

Site Design and Installation

FD300 Series APUs

Application Note

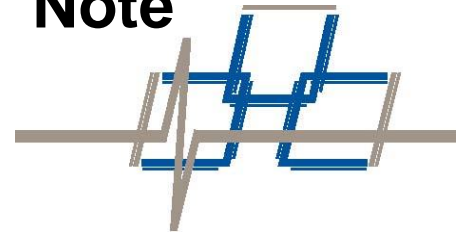

© Copyright 2014, **Fiber SenSys®** all rights reserved. No part of this publication may be reproduced or transmitted in any form or by any means, electronic or mechanical, including photocopy, recording, or any information storage and retrieval system, without permission in writing from **Fiber SenSys®, Inc.**, 2925 NW Aloclek Drive, Suite 120, Hillsboro, Oregon 97124, USA.

This application note is provided by **Fiber SenSys, Inc.** While reasonable efforts have been taken in the preparation of this material to ensure its accuracy, **Fiber SenSys Inc.** makes no express or implied warranties of any kind with regard to the documentation provided herein. **Fiber SenSys Inc.** reserves the right to revise this publication and to make changes from time to time in the content hereof without obligation of **Fiber SenSys, Inc.** to notify any person or organization of such revision or changes.

Fiber SenSys® is a registered trademark of **Fiber SenSys, Inc.**

Fiber SenSys, Inc.
2925 NW Aloclek Dr.
Suite 120
Hillsboro, OR 97124
USA

Tel: 1-503-692-4430
info@fibersensys.com
www.fibersensys.com

Table of Contents

Introduction.....	1
1. Site Assessment.....	2
Possible Threats against Fenced Perimeters	2
Nuisance Alarms	2
General Fence/Perimeter Requirements	3
Zone Length, Sensor Length, and System Resolution.....	3
2. Site Design	6
Determine Zone Count and Zone Locations	6
Cable Routing	6
Fenced and Walled Perimeters	9
Reinforced Fence Sections.....	10
Outriggers (Barbed or Razor Wire)	12
Corners and Posts.....	15
Service Loops.....	16
Wrought Iron Fence	16
"Anti-Ram" Barrier Fences.....	17
Glass Walls	18
Perimeter Walls	18
Protecting Gates	22
Single or Double Swinging Gates	22
Sliding Gates	23
Gates Not Requiring Protection	24
3. System Installation.....	25
Chain Link Fence Specifications	25
Routing the Cable	26
Fiber Handling Precautions	27
Attaching the Sensor Cable to the Fence	28
Frequency of Ties and Pull Tension.....	29
Connecting the Sensor Cable to the APU.....	32
NEMA 4X (IP66) Enclosure.....	32
Mounting the Enclosure	32

Wiring the APU 33

Adding Supervisory Resistors 35

Introduction

The successful installation and operation of a fiber optic security system is achieved by a thorough understanding of the security needs of the site to be protected as well as proper deployment of the sensor cable. This application note will lead the reader through the site design and installation procedures for various safety and security applications.

Prior to installing the Alarm Processing Unit (APU) and deploying the sensor cable, the site to be protected must be assessed carefully so that all security needs are met and all potential threats against it are accounted for. For example, if there is a possibility that a potential intruder could cut the fabric of a perimeter fence, sensor cable should be deployed along the fabric to detect the intrusion.

In addition to security needs and threat assessment, the system maintenance requirements and compatibility must also be taken into account. For example, if the APU alarm relays are wired to activate remote video equipment, the maintenance requirements and compatibility of the APU and third party equipment should be considered.

Once the site to be protected has been thoroughly assessed for all security needs and the system maintenance requirements and equipment compatibility have been examined, the sensor cable must be properly deployed.

Ultimately, the method by which the sensor cable is installed and deployed is up to the end user. Fiber SenSys does not mandate one particular installation design over another; however, the general procedure for installing the fiber optic perimeter security system is as follows:

1. **Assess:** Survey the site to be protected and record all information needed for the site design phase
2. **Design:** Create a strategy for protecting the site. This includes planning the level of security, choosing the location of the APUs, provision of electrical power, and planning cable routing
3. **Install:** Proper deployment of the fiber optic sensor and correct installation of the Fiber SenSys system

1. Site Assessment

Site assessment is used to evaluate the security needs of a site and to gather important information used for site design. This process involves the following:

- Survey the perimeter and record:
 - Length of the fenced perimeter
 - Fence type (chain link, palisades, decorative, etc.)
 - Locations, lengths, and types of all gates (swinging or sliding)
 - Presence of outriggers or concertina wire
 - Security strengths and weaknesses

- Collect the system requirements:
 - Zone resolution/length (the number of zones is a function of this)
 - Level of security (high, medium, etc.)
 - Types of security threats
 - Additional layers of security (cameras, lights, etc.)

Possible Threats against Fenced Perimeters

There are six primary types of threats against fenced perimeters:

1. Climbing the fence fabric
2. Climbing the fence posts
3. Cutting through the fence fabric
4. Digging under the fence
5. Lifting and crawling under the fence fabric
6. Ladder-assisted climbing over the fence

Any site can effectively protect against all of these threats through the proper sensor installation, optical assembly, and processor calibration and tuning.

Nuisance Alarms

As part of the assessment of the site, take into account possible non-threatening trespasses that could trigger an alarm, such as animals, wind, and tree limbs.

Prior to system installation, take all steps necessary to eliminate nuisances by trimming or removing tree branches and shrubs encroaching the fence line, removing oversized signs on the fence, and restricting guard dogs and other wildlife in the area.

In many cases, some sections of fence may be more prone to nuisances such as higher winds, nearby traffic or trains, or more heavily wooded areas. If all possible nuisances cannot be removed before system installation, the affected zones can be tuned to resist potential nuisances.

General Fence/Perimeter Requirements

To ensure that the system successfully detects intrusions, the fence should meet the following requirements:

1. The fence should not generate excessive vibration or noise. For chain-link fences, re-tensioning the fence fabric and adding additional tie wires to eliminate metal-to-metal banging during wind effectively quiets the fence. Ensure that the fabric is secured firmly to all fence posts.
2. The fence should be composed of the same material (similar gauge and construction) along the entire length of each zone. Perimeters with multiple types of perimeter media should plan their zone breaks at these transition points.
3. Keep a clear area on both sides of the fence; all climbing aids such as trees, large rocks, and structures should be removed or secured. Also, there should be nowhere along the fence where an intruder could easily crawl or dig underneath without disturbing the sensor.
4. Buildings, structures, waterfronts, and other barriers used along the perimeter in place of the security fence should provide adequate protection against intrusions. Ensure that there are no windows, doors, openings, or other unguarded means of access.

Zone Length, Sensor Length, and System Resolution

The lengths and placements of the zones are determined by the site requirements. The zone lengths need to be set such that the location of intruders can be determined accurately within the needed response time of the site. Other factors might include requirements for gates, culverts, and other discrete structures to be individually alarmed with their own zones. Additionally, camera viewing limitations should be taken into account. The length of sensing fiber required for a given zone depends on the following:

1. Length of the zone
2. Security level for the zone
 - High
 - Medium
 - Low
3. Fence construction
4. Number of poles and cross-braces

For example, a low-to-medium security installation design may require a single pass of the sensor cable down the middle of the fence, in which case the length of the sensing cable would be approximately the length of the zone with a small amount added for service loops. Whereas, a high-security application may require two passes along the fence, as well as vertical loops up and down

each outrigger. In high security applications, the length of the sensing cable may be more than 3 times as long as the physical length of the zone.¹

Long fence-line perimeters should be divided into multiple zones in order to be effectively protected. The zone lengths are determined by how the security system will respond to intruders. When estimating the sizes of zones, it is helpful to use the concept of the Response Perimeter of Influence (RPI). RPI is the length of the perimeter that can be effectively secured once an alarm is activated, and it is a function of the speed of the intruder, and the security response time:

$$Zone \leq RPI \leq V_{Intruder} \cdot T_{Response}$$

In words, the RPI is less than, or equal to, the average intruder's speed², multiplied by the response time. To help understand this equation, let's look at two examples:

Example 1:

- A remote site has no on-site security.
- Alarms are relayed to security personnel by phone, after which they must travel for several hours to reach the site.
- Speed of intruder: 7 meters/second (15.7 mph)
- RPI is many km
- In this example the perimeter may need only one zone, even if the entire length of the fence is more than one km long.

Example 2:

- A facility has on-site security.
- Response time, anywhere on the perimeter, is less than 60 seconds.
- Intrusion type: Cut through fence.
- Speed of intruder: 7 meters/second (15.7 mph)
- RPI = 420 meters.
- In this example, the perimeter zones should be about 400 meters so that the security team is provided with the proper resolution for determining the point of intrusion.

It is important to use the equation for RPI as a guide, and not a fixed rule. Also, note the \leq symbol, indicating that the zones should be less than, or equal to, the RPI. Finally, remember to keep other aspects of the security system in mind. For example, if the fiber sensors are going to be used to alert

¹ When concertina wire is secured with sensing fiber, the top guard may have a differing tension than the fence and a separate zone can be used to protect the differing regions on the fence line. In this case, two zones may cover the same physical length of the perimeter, with one zone installed on the fence and the other zone installed on the outriggers.

² The average intruder's speed includes the time spent climbing or cutting through the fence; it includes the stationary time in breaching the perimeter, and in crossing the inside of the perimeter.

a camera system that will locate and focus on the intruder, then the zones must be smaller than the camera's field of view.

2. Site Design

When determining a strategy for protecting the site, there are 3 important points to consider regarding the sensor cable:

- The sensor cable detects motion, vibration and pressure changes. Therefore, the sensor cable should be deployed in such a way that it will ideally be free of these effects unless they are caused by an intruder.
- The sensitivity of the sensor cable is *uniform*, meaning it has the same level of sensitivity throughout the entire length of the cable. Areas that are affected better by vibrations may need a sensor cable run through only once, while areas where vibration is conducted less readily (such as fence posts or reinforced fence sections) should have more sensor cable deployed to compensate.
- The detection system is *zone based*, meaning the APU cannot pinpoint where an event occurs along the sensor cable. In order to localize the point where an intrusion occurs, the APU deployment must be separated into multiple zones at reasonable intervals so that an intruder can be located when an alarm is received.

Determine Zone Count and Zone Locations

Whether a site is protected by multiple zones or a single zone is determined by the size of the site and the ability for site personnel to respond quickly to one or more intruders. Protected sites requiring more than 5 kilometers (16,400 feet/3.1 miles) of sensor cable length should use a multi-zone system.



NOTE: *The difference in the lengths of any two cables (length defined as the distance between any two end connectors) in the system should be greater than 1.5m. The length of any cable in the system must also be greater than 1.5m*

Other factors used for determining the number of zones required include whether or not video surveillance is used (requiring a separate zone for each camera), or whether there are one or more remote sections of the site needing to be monitored in addition to the main site.

Cable Routing

Figure 1 shows three common fence line sensor cable deployments based upon the level of the security:

Single Run (Low Threat Level)

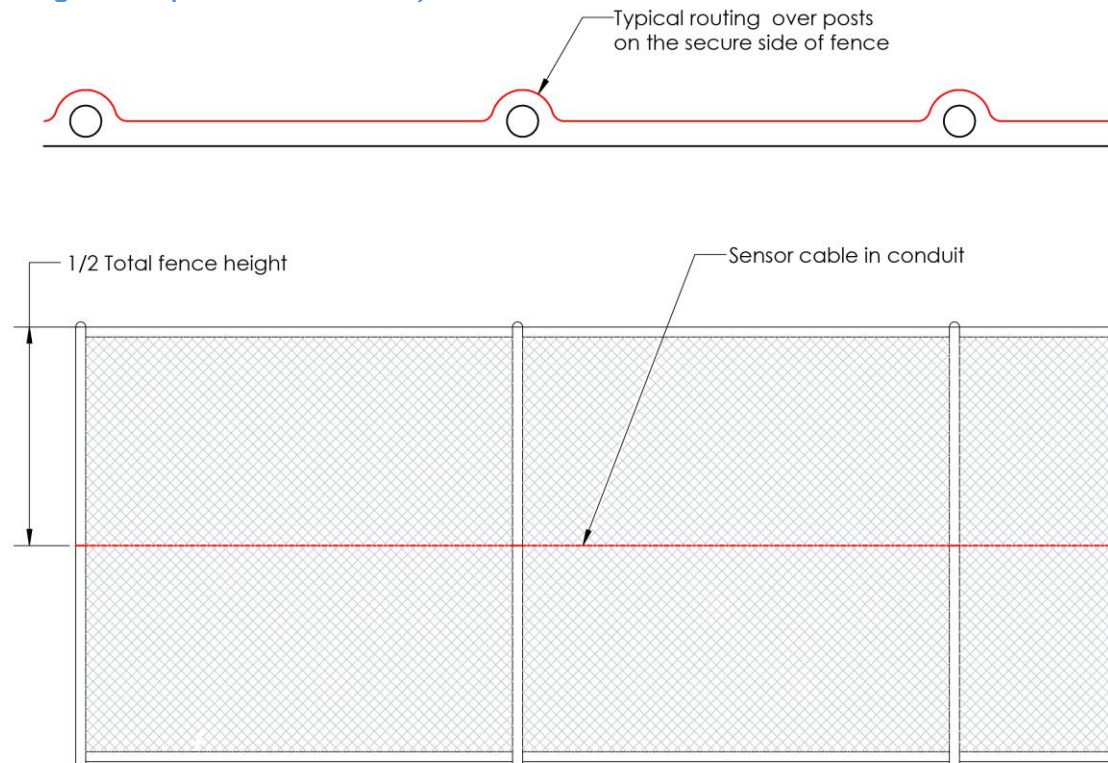

Double Run (Medium Threat Level)

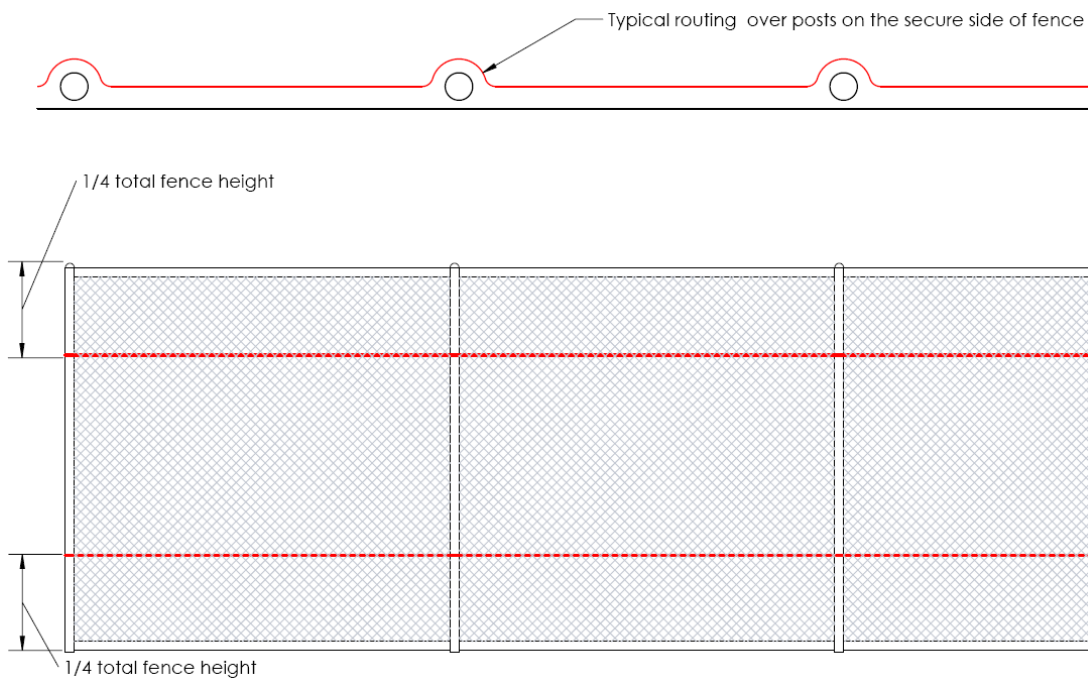

Military Grade High Security (High Threat Level)

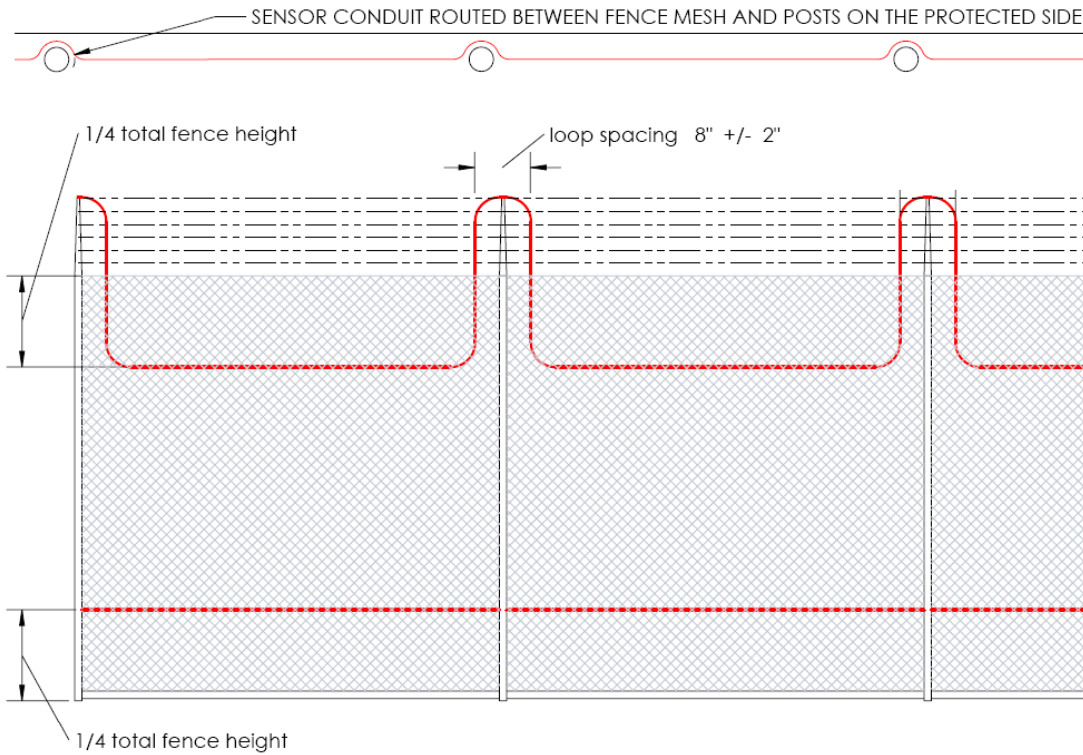

Figure 1: Sensor cable deployment types

Table 1 describes these deployment types in detail.

Table 1

Single Run:	Low threat level deployment where the primary threat is theft and/or vandalism. This deployment detects basic, unsophisticated attempts to climb over, crawl under, or cut through the fabric of the fence.
Double Run:	Low to medium threat level deployment, where more sophisticated intrusion attempts are expected from intruders. Deploying the sensor cable along the lower and upper levels of the fence places the sensor cable in closer proximity to the source of the stealthy intrusion (e.g. intruders attempting to crawl under the fence, climb fence posts, etc.).
High Security:	Maximum detection capability of stealthy intrusion attempts for high security facilities. Sensor cable added to the fence outriggers raises the system sensitivity to catch highly trained intruders.

In medium and high threat level deployments, the sensor cable is routed along the fence in a loop encompassing the length of the zone; this is a configuration known as loopback deployment. The advantage of the *loopback deployment* is that it increases the system's sensitivity for detecting stealthy intrusion attempts.

For all loopback deployments, the sensor cable loop is attached 1/4 of the fence height from the top rail and 1/4 of the fence height from the bottom rail. When the fence is extremely tall (16ft or over), a quadruple run may be necessary.

To further increase the system sensitivity the sensor cable should be routed between the fence fabric and the fence posts. The sensor cable should also overlap from one zone to the next for medium and high threat level deployments. With high threat level installations, running additional sensor cable loops up the outriggers protects against intruders climbing the fence posts and ladder assisted climb attempts.

Multi-zone APUs are capable of supporting numerous zones or sensor cable deployments. Users have the option of installing the sensor cable for all channels in the same type of application or in different applications. There could be one zone on a fence and another zone on a perimeter wall, for example.

There are many ways to deploy the sensor cable to protect a fence line. Choose a cable deployment strategy that best protects the fence line against the types of intrusions considered during threat assessment.

While developing a strategy take note of and record:

- The length of the fenced perimeter
- The style(s) of fence installed (wrought iron or chain link)
- The type of gates that are deployed onsite (swinging or sliding)
- Distance from the fence to the APU
- The width of roadways or walkways through all site gates

NOTE:



Keep a detailed list of these perimeter measurements because they will be used during the installation procedure.

Fenced and Walled Perimeters

To ensure a fence line sensor cable successfully detects intrusions into fenced perimeters, the following considerations should be taken into account:

Fence Noise

The fence should not generate excessive noise. For chain link fences, re-tensioning the fence fabric and adding additional fence ties to eliminate metal-to-metal banging reduces fence noise. The fence fabric should also be secured firmly to all fence posts.

Fence Material

The entire fence line of each zone should be composed of the same fence material (similar gauge and construction). For a chain link fence, all of the fabric in the zone should be tensioned to the same level.

Fence Clearance

There should be a clear area to either side of the fence, free from tree limbs, large rocks, or structures - man-made or natural - which could aid an intruder in climbing over. There should not be any point along the fence line where an intruder could easily crawl or dig beneath the fence.

Man-Made and Natural Barriers

Buildings, structures, waterfronts, and other barriers used in place or as part of the fence line should provide adequate protection against intrusion. Ensure there are no windows, doors, openings, or unguarded means of access.

The following sections outline recommended sensor cable deployment strategies for different barrier types.

Reinforced Fence Sections

Because reinforced fence sections are less likely to transmit vibrations as readily as non-reinforced fence sections, reinforced fence sections require additional cable in order to normalize sensitivity throughout each zone. The recommended way of accomplishing consistent sensitivity is to add additional "sensitivity loops" of sensor cable in the reinforced sections as shown in figure 2. In effect, adding the loop increases the amount of sensor cable per unit of area, resulting in a net increase in vibration sensitivity in the affected section.

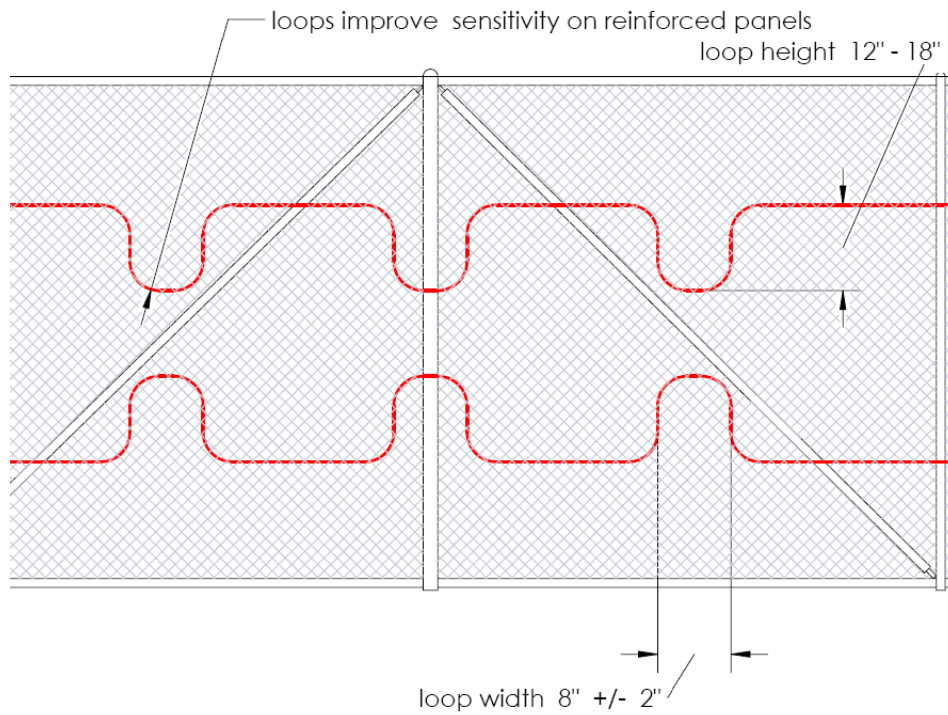

Figure 2: Deployment in a reinforced fence section

As a rule of thumb, the extra loop is added to both the top and bottom strands of sensor cable (for a loopback deployment). Make the width of the loop(s) between 20 and 25 cm (8 and 10 inches).

The cable deployment in reinforced sections differs when a high threat design is implemented on the fence. In such a case, the sensor cable is attached just 5 cm (2 inches) from the bottom rail of the fence, as shown in figure 3. In all non-reinforced sections, the sensor cable is attached 1/4 of the fence height above the bottom rail.

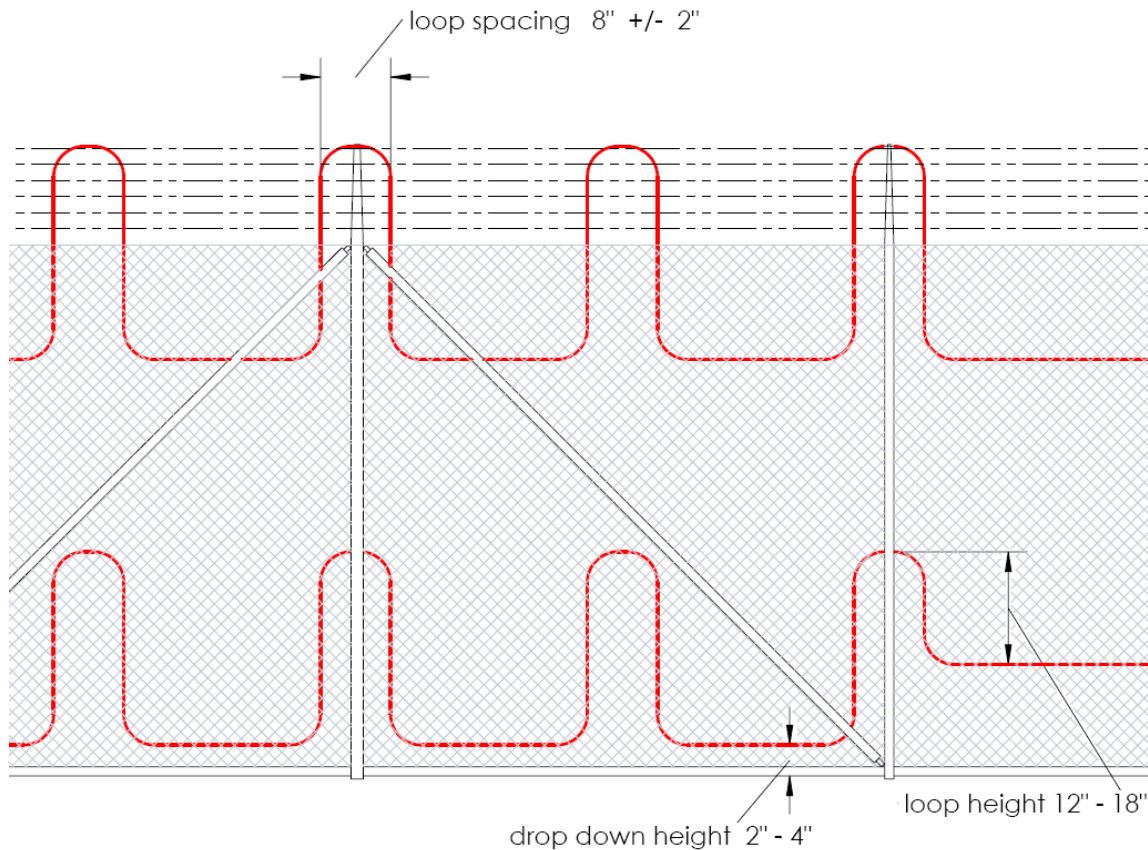

Figure 3: Detail of a reinforced section with an outrigger

In a high threat installation, the vertical loops of the sensor cable should extend to the top of the outriggers. As with the fence posts, the sensor cable is run between the fence fabric and reinforcement bars where possible.

The added loops on the fence posts increase the system sensitivity in the region and the sensing cable implemented on the barbed wire helps to protect against ladder intrusions. Ensure that a wire tie is added at each intersection between the barbed wire and conduit so that all kinetic energy is transmitted to the sensor.

Outriggers (Barbed or Razor Wire)

The typical way of protecting an outrigger that supports barbed wire or razor wire is to deploy sensor cable across it. In the case of barbed wire, this means looping the sensor cable across all strands as shown in figure 4.

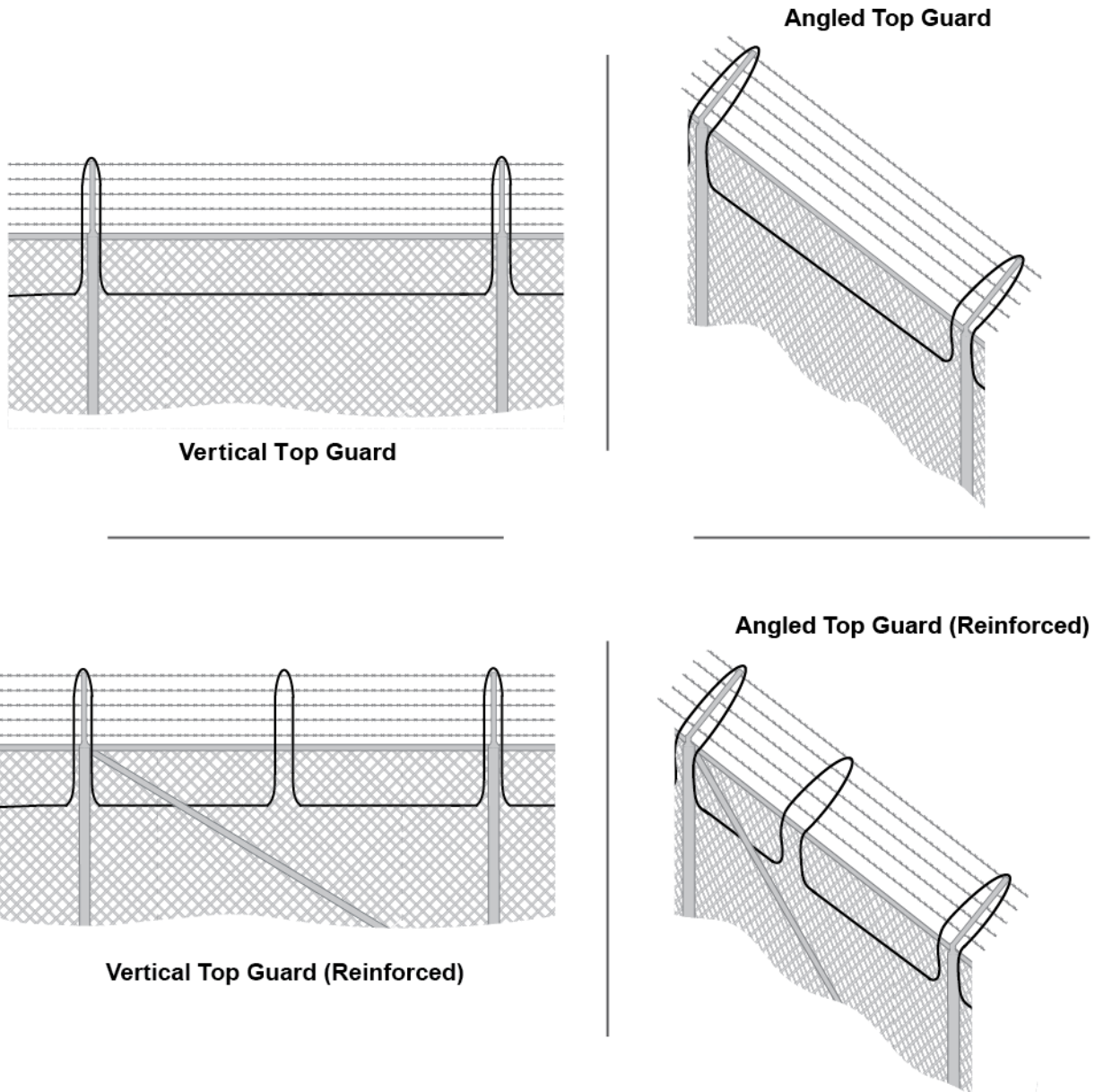

Figure 4: Examples of barbed wire sensor deployment

In all cases where barbed wire is used with a chain link fence, the sensor cable should be deployed in the high security configuration as shown in figure 1. Ensure that the cable loops extend to the top, which protects each outrigger. An extra cable loop must be added to the middle of the fence panel for reinforced sections (see figure 4).

If razor wire (also known as concertina or "c-wire") is used as a top guard, the recommended deployment method is to attach the sensor cable to the inside of the razor wire coils.

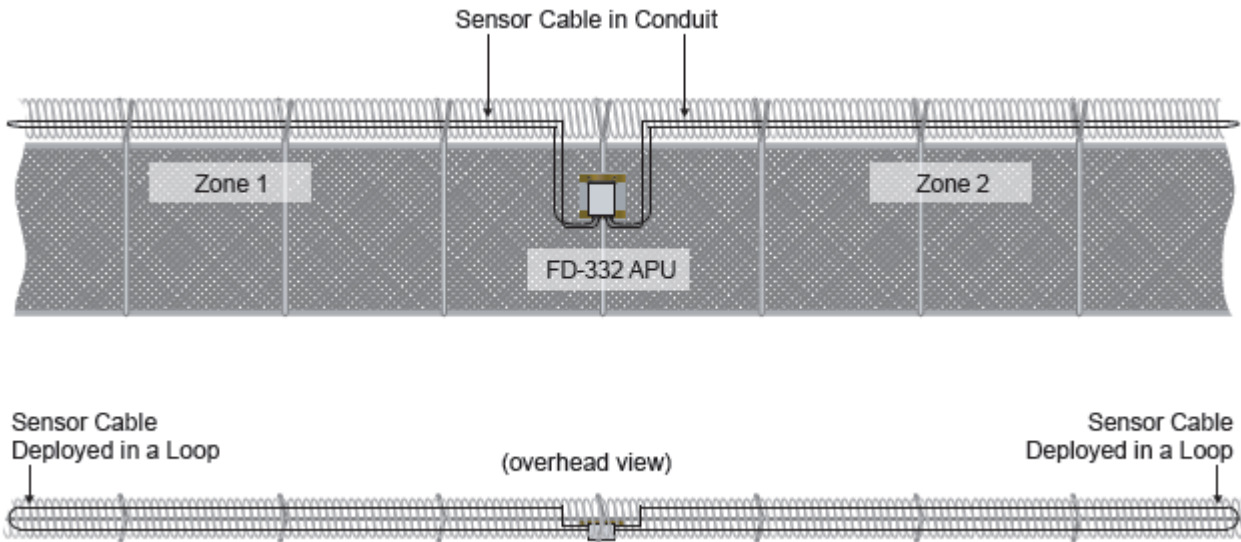

Figure 5a: Razor wire sensor cable deployment

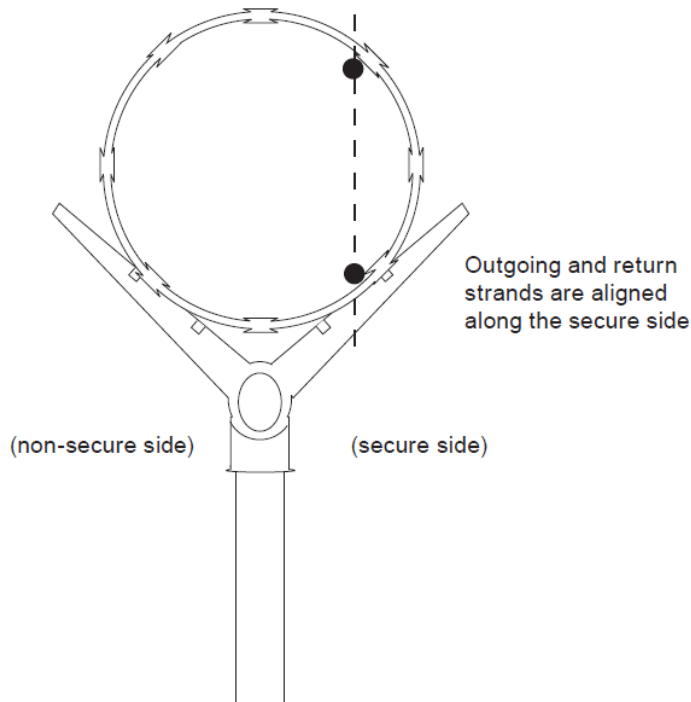
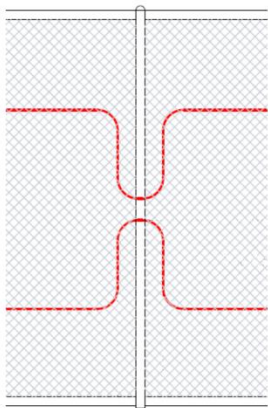

Figure 5b: Sensor cable placement on concertina wire for "loopback" deployments

Corners and Posts

Because corners and posts are rigid and less likely to transmit vibration, they should be protected by adding extra sensor cable in a loop as shown in figure 6. It is also recommended that zones end at corners, which ensures that the zones are more uniformly affected by wind and makes it easier to tune.



Posts

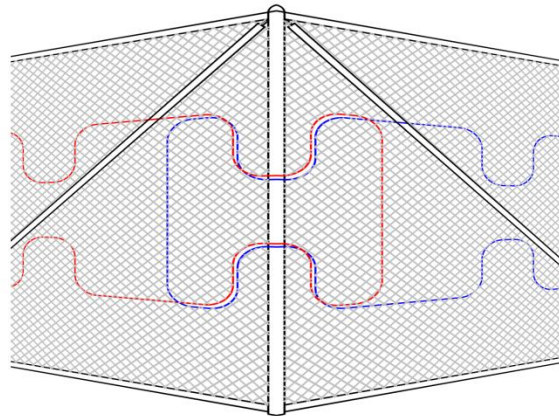

Corner Posts

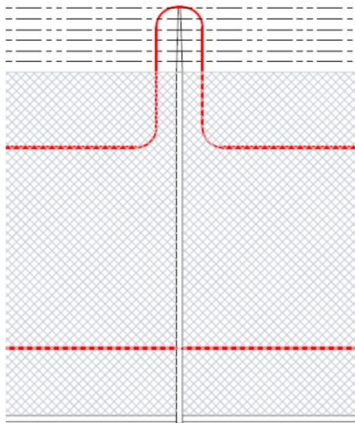

Posts with Outriggers

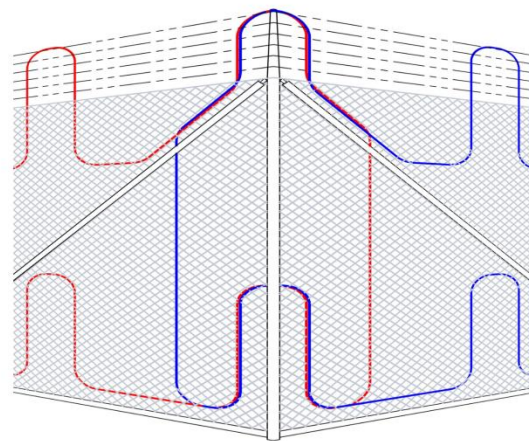

Corner Posts with Outriggers

Figure 6: Fence post protection methods

For fences with outriggers, the cable loop should extend up to the top of the outrigger, protecting both the post and the outrigger. Because most fence sections are reinforced at corners, the prescribed method for deploying sensor cable in reinforced sections should be followed.

Service Loops

Loops should be added at periodic intervals to allow the sensor cable to be re-spliced with the excess cable should there be an accidental break. A good rule of thumb is to use one service loop every 91 meters (300 feet) or so. In general, plan on using an additional 1.5 meters (5 feet) of cable with each sensor loop.

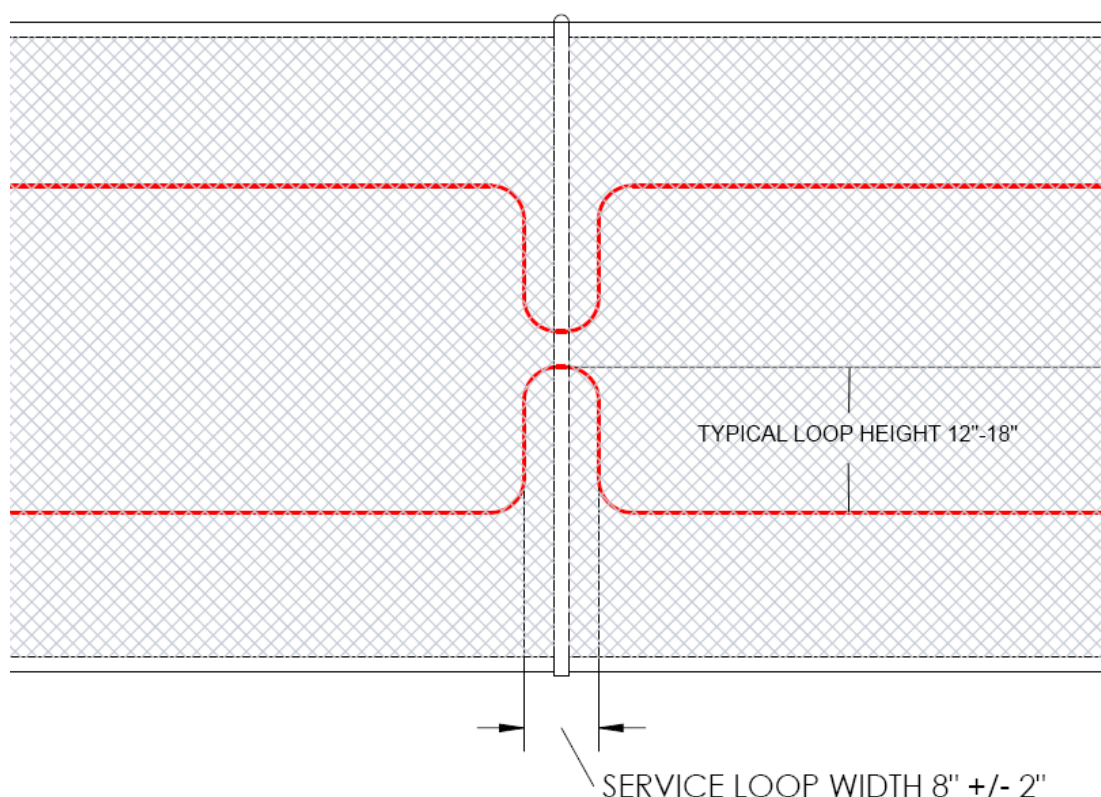

Figure 7: Service loop in sensor cable

Wrought Iron Fence

With proper deployment, the sensor cable can protect a wrought iron fence as well as it protects a chain link fence. For such an instance, the sensor cable is best installed along the top and bottom horizontal fence rails. Because a wrought iron fence is designed to be rigid, the APU must be calibrated carefully to ensure that nuisances have a minimal effect while anti-intrusion capabilities are maximized.

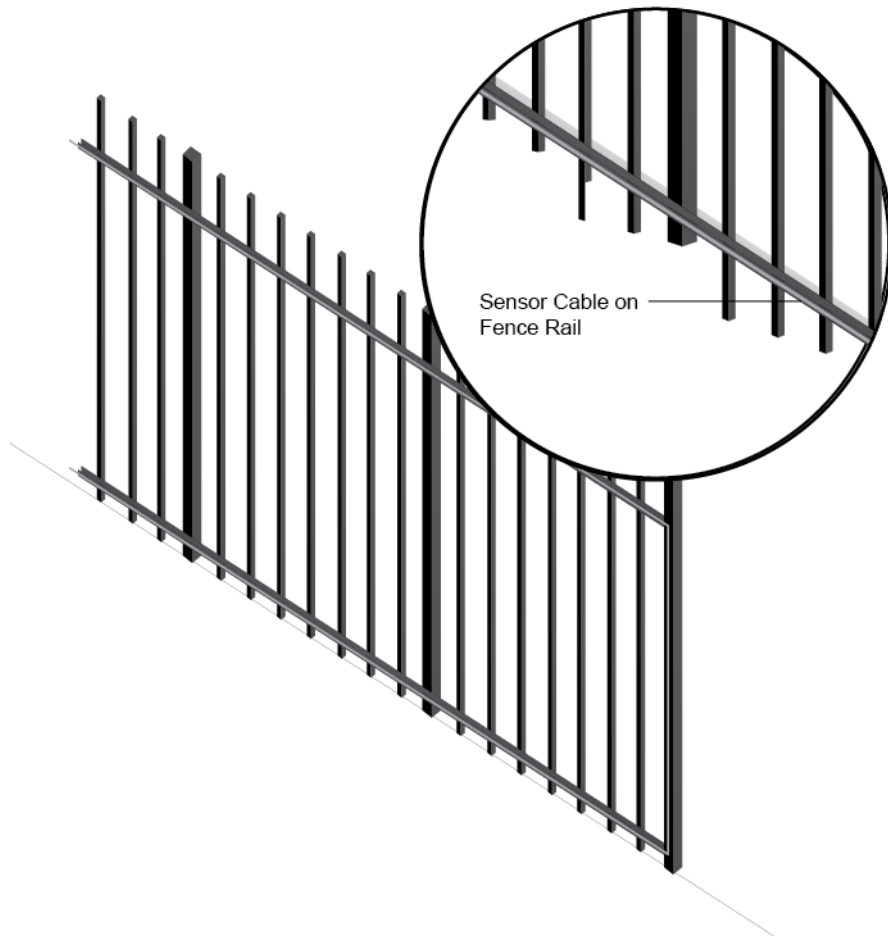

Figure 8: Deployment on a wrought iron fence

"Anti-Ram" Barrier Fences

Modern fence manufacturers have created various versions of "anti-ram" barrier fences for the purpose of restricting automotive access. These barriers resemble wrought-iron fences in appearance and are made to withstand direct, high-pressure impacts from heavy vehicles. Such barriers are successful because they have built-in channels, allowing for the insertion of heavy, rolled-steel reinforcement cable; these channels are also ideal for inserting sensor cable.

With an anti-ram barrier fence, the fiber optic sensor cable is implemented much like a standard wrought iron fence deployment. The cable is inserted into conduit (usually black in color) and attached to the top and bottom rails or channels. Secure the conduit/sensor cable assembly in place using UV-resistant cable ties. On most anti-ram barrier fences, the channels have been perforated with cutouts every 15 cm (6 inches) to allow cable ties to be threaded through.

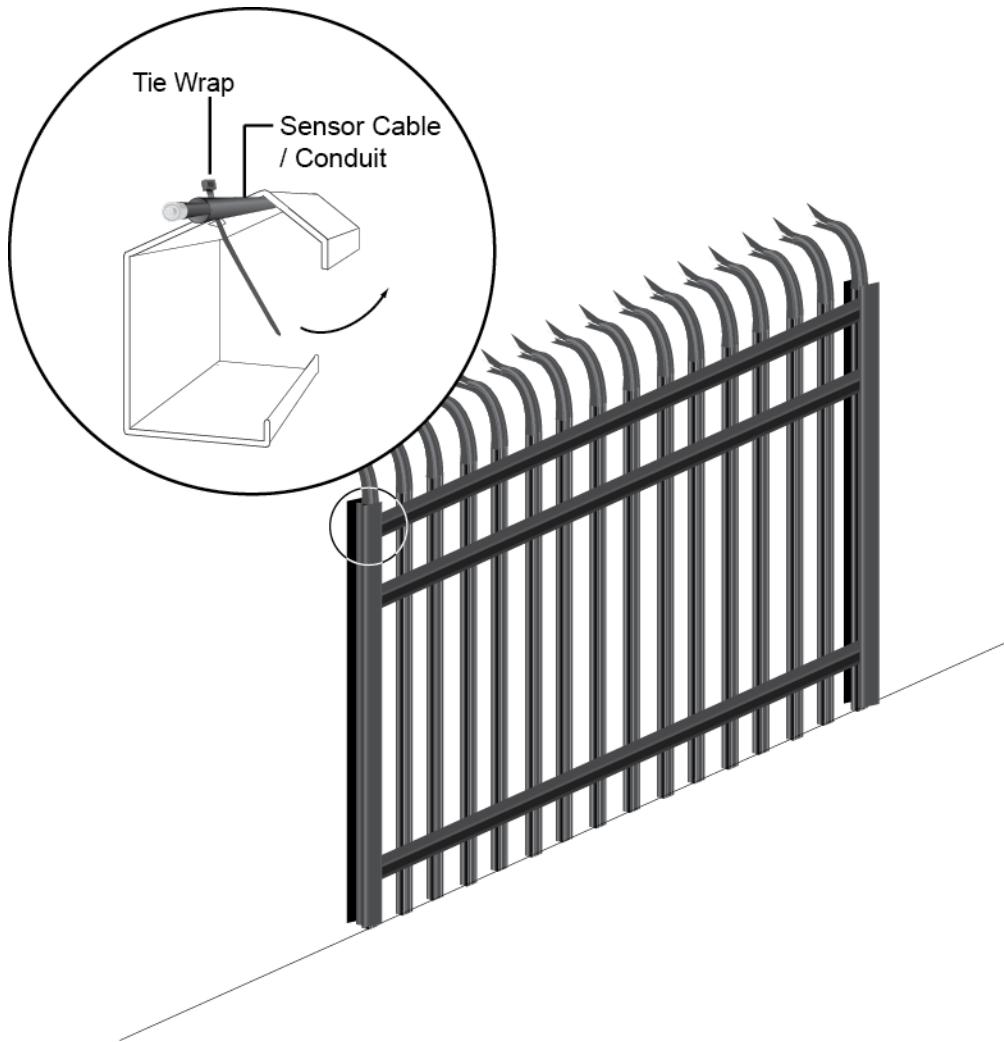

Figure 9: Adding sensor cable to an anti-ram barrier fence

Glass Walls

The sensor cable can be mounted flush against the surface of the glass wall and detect virtually any threat against the glass. When deploying the cable, consider the need to place the cable so it is inconspicuous and develop a strategy accordingly. Also, consider the effect of possible nuisances such as wind, low frequency vibrations from aircraft, animals tapping against the glass, etc.

Perimeter Walls

Concrete resting caps containing SC-4 sensing fiber are often used in residential areas for decorative purposes with many brick wall perimeters. Decorative foam caps that mimic the appearance of concrete resting caps can be used in their place, which make ideal platforms for concealed sensor

cable. Sensor cable placed under a loose resting cap will detect an intruder attempting to climb over top of the wall (figure 10).

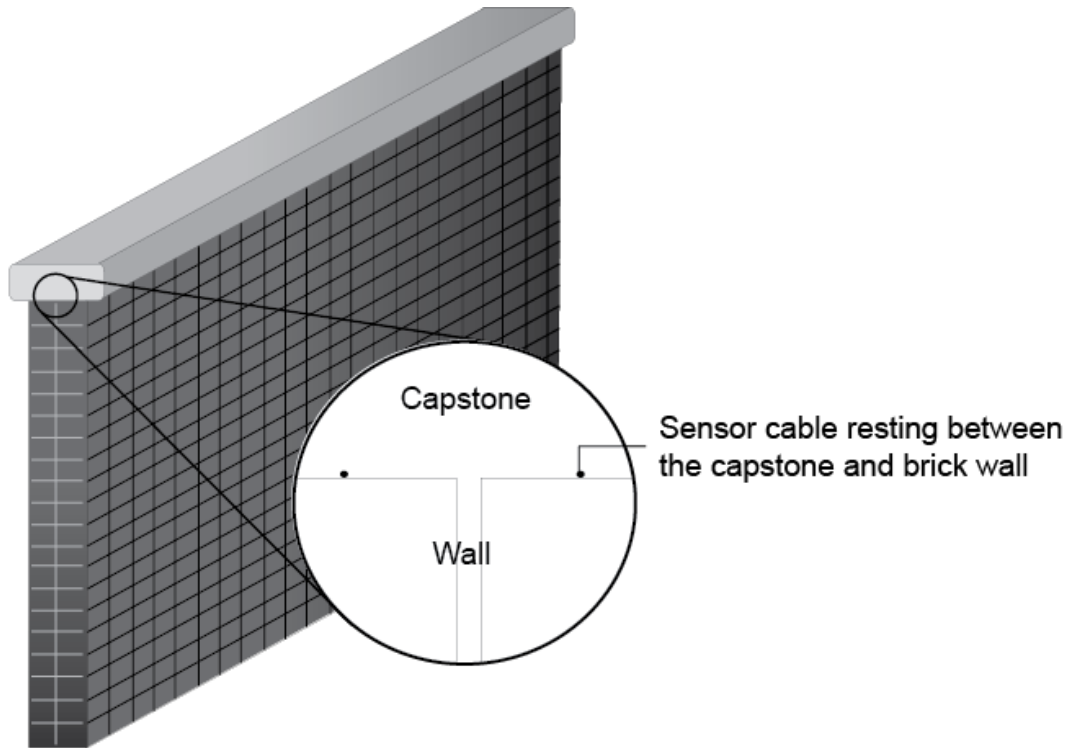

Figure 10: Deployment under a loose resting cap

When deploying sensor cable within a wall cap, use a loopback configuration and ensure there is equal weight distribution of the resting cap across the sensor cable (two cable strands can carry the weight evenly, as opposed to a single strand of cable which forms a fulcrum). Wall caps with sensor cable channels can also be used. Keep in mind that the resting cap should be secure enough to prevent movement during strong winds. Likewise, it should be unaffected by the presence of small birds, squirrels, etc.

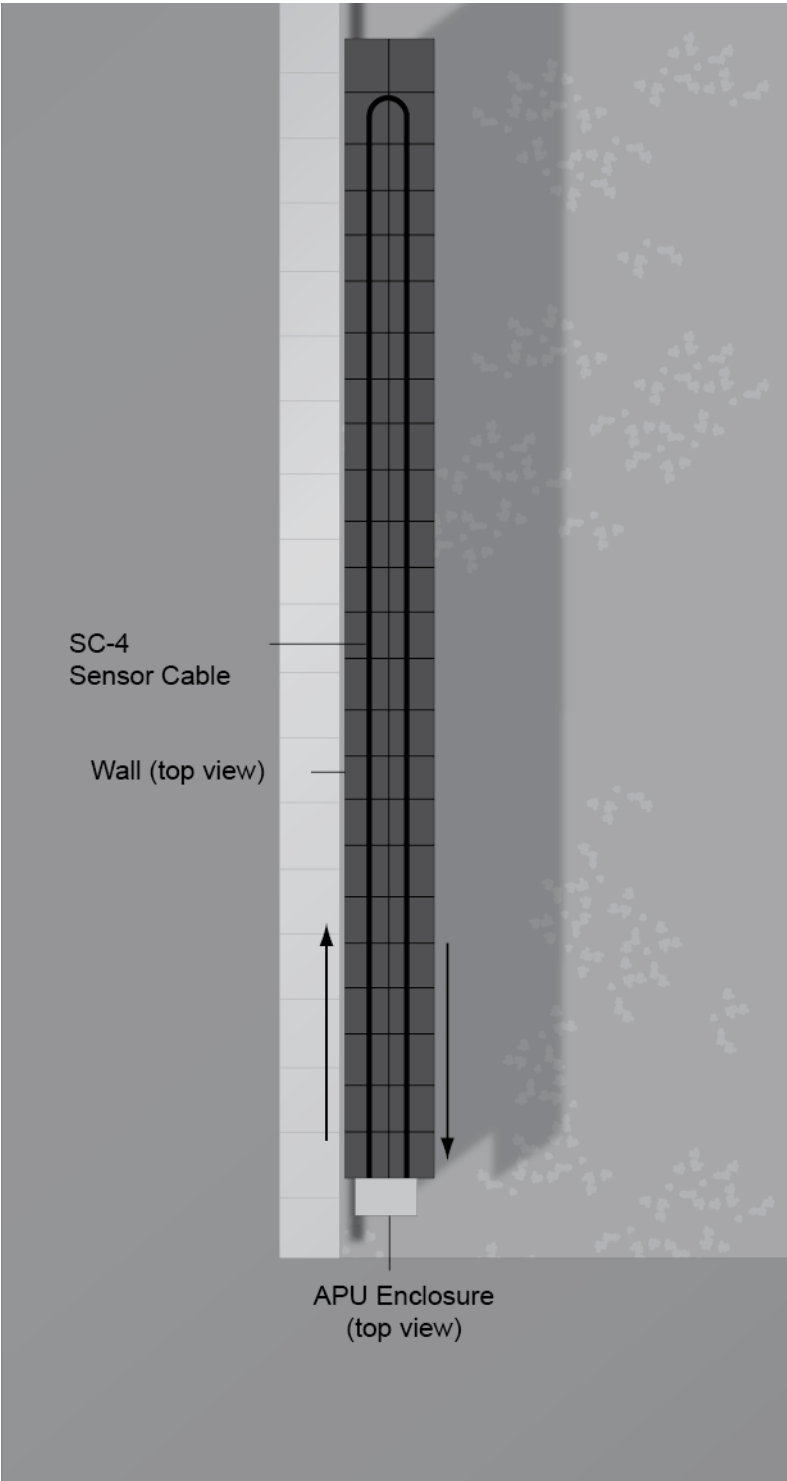

Figure 11: Loopback deployment below the capstone (top view)

Covertly installed SC-4 sensor cable must be used beneath a decorative foam wall cap.

Sensor cable can be deployed on outriggers to protect concrete perimeter walls without capstones. This configuration is also designed to detect intruders attempting to climb over the top or using ladder assisted climbs.

Outriggers used to support the sensor cable should be embedded in the wall at least 2.5 cm (1 inch) or more and should have approximately 10 cm (4 inch) of clearance from the top of the wall. Outriggers should be embedded near the outside edge of the wall at approximately a 45° angle to ensure any attempt to scale the wall using a ladder will be protected. As with brick wall/capstone deployments, the sensor cable should be deployed in a loopback configuration (see figure 12).

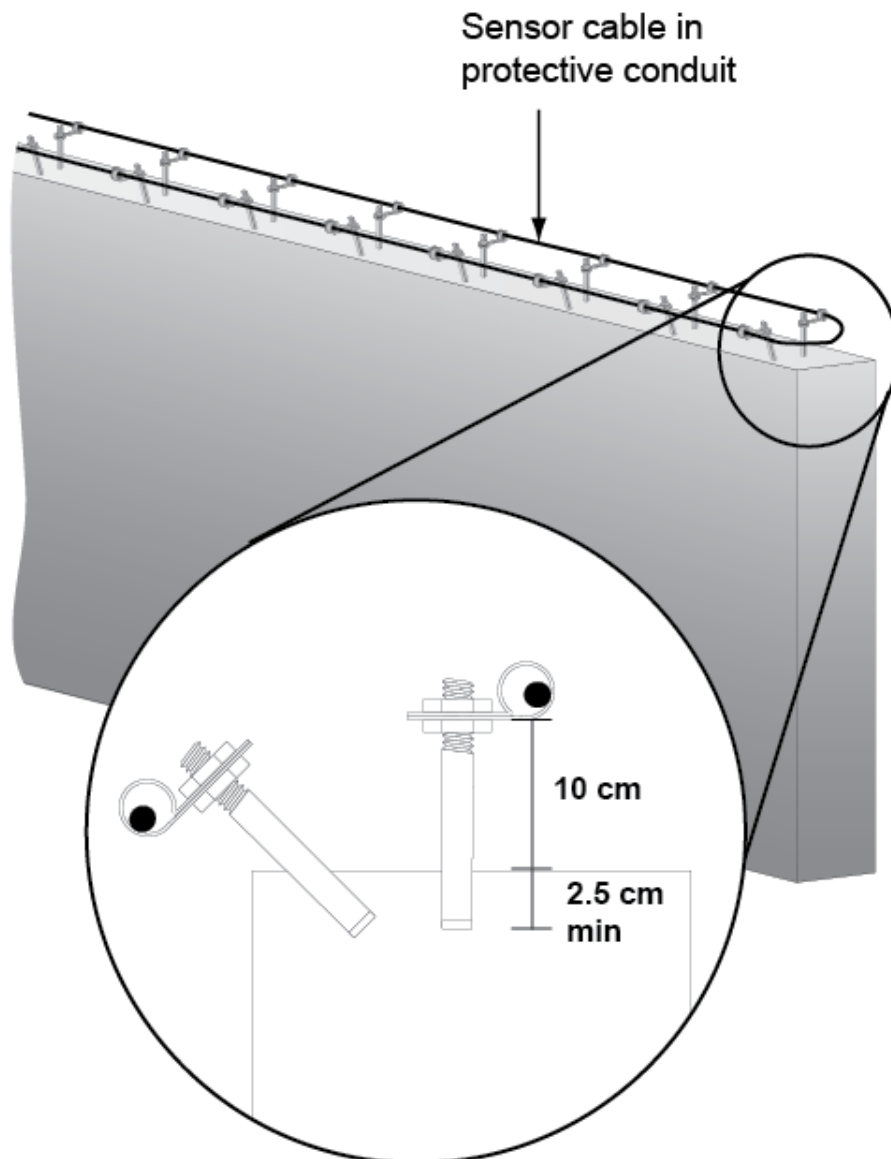

Figure 12: Protecting a concrete perimeter wall

All sensor cable should be deployed inside protective conduit with this configuration.

Protecting Gates

Gates pose a unique complexity for fence line sensor cable deployment because they are designed to move. While the non-static properties of gates pose a challenge, sensor cable can still be deployed if the following points are accounted for:

- Gates can be a source of nuisance alarms during high wind conditions if they bang into restraining posts, locking mechanisms, or their own latches. Therefore, it is important to secure all gates against unintended movement.
- Although sensors installed on or near gates can often be configured to ignore opening and closing activity, some gate designs work better than others. Consider an alarm disabling circuit for ignoring opening and closing activity during authorized access.
- Establishing a separate zone for the gates can help to maintain a secure perimeter while gates are open. In addition, use care to reinforce sections of the fence leading to the gate(s) by adding additional structural support or posts. Separate the gate hinge post and fabric supporting posts as necessary. Isolating the gate from the fence is recommended to prevent or reduce vibrations transmitted from the gate to the sections of the fence with active sensor cable.

There are a number of ways to deploy the sensor cable for protecting gates. Some of the most common methods are discussed in the following sections.

Single or Double Swinging Gates

For swinging gates, the simplest method is to run the sensor cable from the fence fabric to the gate and loop it back. There is no danger in using the sensor cable as a hinge provided it is adequately shielded in flexible conduit and routed correctly. Ensuring that the sensor cable in conduit is routed in a vertically crossing fashion at the hinge allows the cable in conduit to rotate rather than bend while the gate is used. If a zone extends across a swinging gate, the sensor cable is typically routed below the gate and buried in hardened PVC or metal conduit at least 0.3 meters (1 foot) below the roadway surface to dampen vibrations from the roadway. The cable may also be routed above the gate if a barbed wire outrigger extends over the swinging gate section.

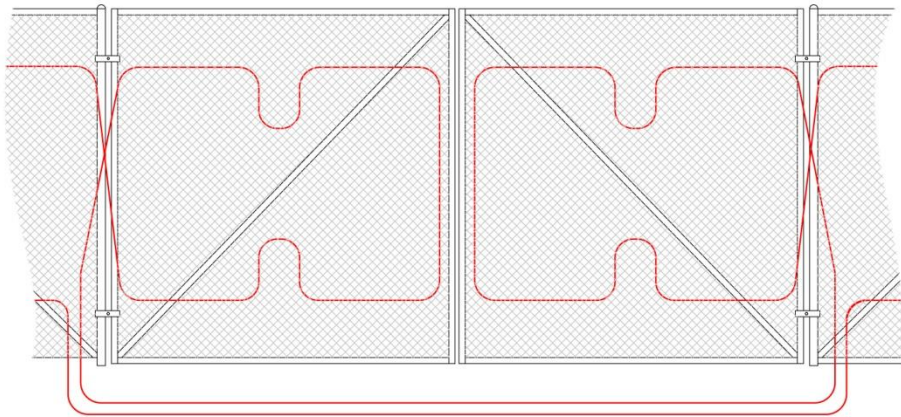

Figure 13: Sensor cable deployed on swinging gates

Sliding Gates

Although sensor cable cannot be mounted practically on the sliding gate itself without additional equipment, sensors can be mounted on the support rail (figure 14) to detect gate movement. In many cases, the support rail can conduct physical disturbances from the gate to the sensor.

As with the swinging gate application, if a zone extends across a gate, the sensor cable is routed within underground rated rigid conduit and buried at least 0.3 meters (~1 foot) below the roadway surface. Burying the conduit the proper depth beneath the roadway makes the cable insensitive to vibrations.

When traffic from heavy vehicles is expected, the cable may need to be buried a full meter (~3 feet) below the surface.

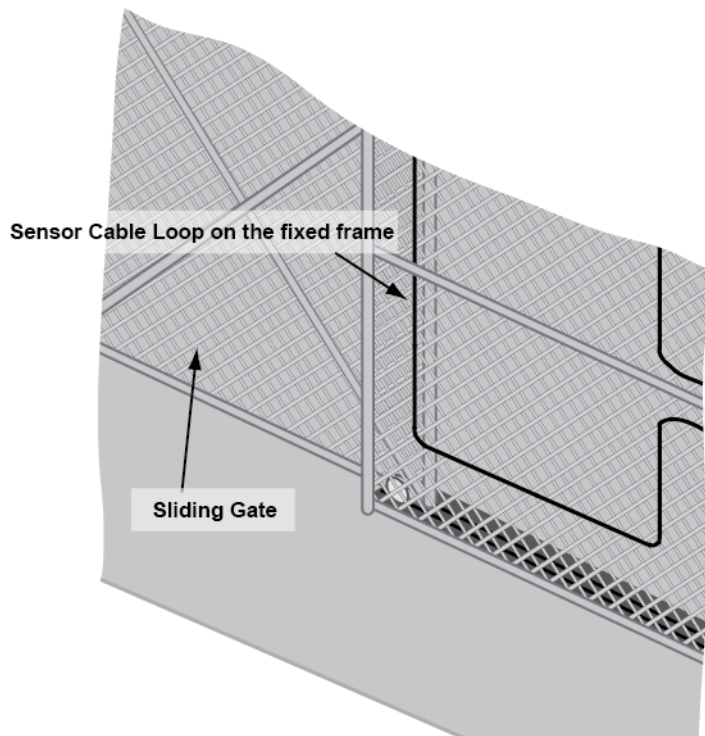

Figure 14: Sensor cable deployment on a sliding gate

Gates Not Requiring Protection

For gates that do not require protection, it is recommended that the cable be routed and buried 0.3 meters (1 foot) or more below the roadway in rigid metal or PVC conduit. This creates a gate bypass that is insensitive to vibration from the roadway.

3. System Installation

Once the site to be protected has been thoroughly assessed for all security needs and the system equipment compatibility has been examined, the sensor cable needs to be properly deployed.

Chain Link Fence Specifications

A chain link fence can be most effective against intrusion if it conforms to the eight specifications outlined below:

Fabric

The fence fabric should be composed of at least 9 gauge steel having openings not larger than 5 cm (2 inches). Additionally, the fabric should be tensioned consistently throughout the protected zone.

Fabric Ties

A minimum of 9 gauge steel ties or larger are recommended. The fabric ties should be electrolytically compatible with the fence fabric to prevent corrosion. The fence fabric should be attached to posts using at least 4 evenly-spaced fence ties. All ties should be tight enough against the post to eliminate or significantly reduce mechanical noise.

Top Guard Outrigger

Outriggers should angle out in the direction of the unprotected area. At least three strands of barbed wire should be attached perpendicularly to the top guard. The barbed wire should be well tensioned and fastened where needed to eliminate mechanical noise.

Height

The height of the fence should be at least 2.1 meters (7 feet).

Fence Posts, Supports, and Hardware

All posts, supports, and hardware should be pinned or welded down to prevent disassembly of the fencing or removal of its gates. All posts and structural supports should be located on the inner side of the fencing. Posts should be secured in the soil with cement to prevent shifting, sagging, or collapse. Additionally, posts should be placed every ten feet or less.

The use of "hog rings" and aluminum wire is not recommended.

Reinforcement

Taut reinforcing wires should be periodically installed and interwoven or affixed with fabric ties along the top and bottom of the fence for stabilization of the fabric.

Ground Clearance

The bottom of the fence fabric should be within 5 cm (2 inches) of firm soil or the base of the fence should be buried sufficiently in soft soil.

Culverts and Openings

Culverts underneath or through a fence should consist of pipe 25 cm (10 inches) in diameter or less. If a larger pipe must be used, it should be properly grated and equipped with sensors to prevent access.

For more information on these requirements, refer to *Security Fence Construction Requirements*, which is a document that is available from Fiber SenSys' website.

Routing the Cable

SC3-C, which is our 3mm sensing cable already contained within 1/2" conduit, is the preferred cable type because it is less expensive and the sensing fiber is pre-pulled into the conduit. Pulling cable into conduit is a time consuming task and requires additional planning. Never cut the cable in conduit sections prematurely; it is far better leave too much cable in conduit for a zone than not enough.

The best place to start applying wire ties is on the top section of the fiber loop located at the beginning of the zone. Begin by leaving at least 1 meter (3 feet) of slack at the APU. After fully attaching the fiber loop to the fence, the 1 meter excess conduit will be trimmed back revealing the inner optical cable and attached into the source junction box using a box coupler. Within the breakout box, the optical cable will be spliced into the insensitive lead-in or terminated directly into the FD300 Series Alarm Processing Unit depending on the APU model.

Depending on the level of security, the cable in conduit may need to be routed between the chain-link panels and fence poles. Routing the cable around the outside of the fence poles rather than between the poles and panels decreases the sensitivity at the rigid pole sections. Routing the cable between the fabric and poles is also advantageous because it makes the sensor more difficult to remove. If the fence cannot be disassembled for routing we recommend pounding stakes in at each pole to create a gap as shown in figure 20. Remove the stakes after the sensor has been permanently attached to the fence.



Figure 20: Wooden stakes can be used to create a gap between the fence fabric and the fence post to allow for high security routing of the sensing cable.

Fiber Handling Precautions

Optical fiber is fragile because it is made of glass. It will break if it is twisted or bent into too tight of a bend radius. The following precautions should be followed when handling fiber optic cable:



CAUTION

Failure to follow these precautions may result in damage to the fiber and degraded or poor system performance.

- The cable should not be pulled by the connectors. Excessive pulling on the fiber terminations could damage the connectors and result in degraded performance
- Avoid twisting the cable or bending it into a radius tighter than 5 cm (~2 inches). This could damage the fiber or break it

- In order to keep the connectors free of dirt and dust, keep the connectors capped until you are ready to make a connection
- Connectors should be cleaned prior to making a connection. If dirt gets onto the tip of the connector, remove it using isopropyl alcohol and a clean, lint-free cloth

Attaching the Sensor Cable to the Fence

Where and how the cable is attached depends upon the type of fence and the possible threats against it. Generally, the sensor cable is attached in such a way that it detects movement or vibration from intruders but still remains as insulated from nuisances as possible. In addition, the cable is also attached in a secure fashion to prevent intruders' access.

Stainless steel wire ties offer the highest security method for attaching our sensor to chain link fences because of their extreme durability.

A special tool is then used to twist the tie so that the conduit/cable assembly is secure on the fence but isn't so tight it inhibits proper operation of the sensor or damages the conduit. The simplest process for attaching a wire tie is as follows:

1. Bend the tie at the midpoint so there is roughly a 45° fold
2. Route the tie through horizontally adjacent fence diamonds
3. Squeeze the circular ends together and insert the hook of the twist tool
4. Pull the tool towards your body for approximately 3½ pulls
5. Secure the tie so that it is snug yet not digging into the conduit

NOTE:



In areas that are exposed to salt spray, limit the number of pulls to 2 (so that there are approximately seven twists in the tie). Ties in oceanic areas can be susceptible to "stress corrosion cracking" when high tension is applied, the solution to this phenomenon is applying less stress to the tie.

Logically one would assume that the best way to apply wire ties to a horizontal run of conduit would be to route the ties vertically between adjacent fence diamonds. However, the highest security method of routing ties on both vertical and horizontal conduit runs is by routing the tie through horizontally adjacent fence diamonds. When ties are routed through horizontally adjacent diamonds, the ties burrow tightly within the framework of the fence as shown in figure 21a. If the ties are strung through vertically they do not conform to the fence, which leaves small gaps that can be cut from the non-secure side of the fence as shown in figure 21b.

Correctly Installed Tie



Figure 21a: Observe how the tie fits tightly within the framework of the fence when correctly routed across horizontally adjacent diamonds

Incorrectly Installed Tie

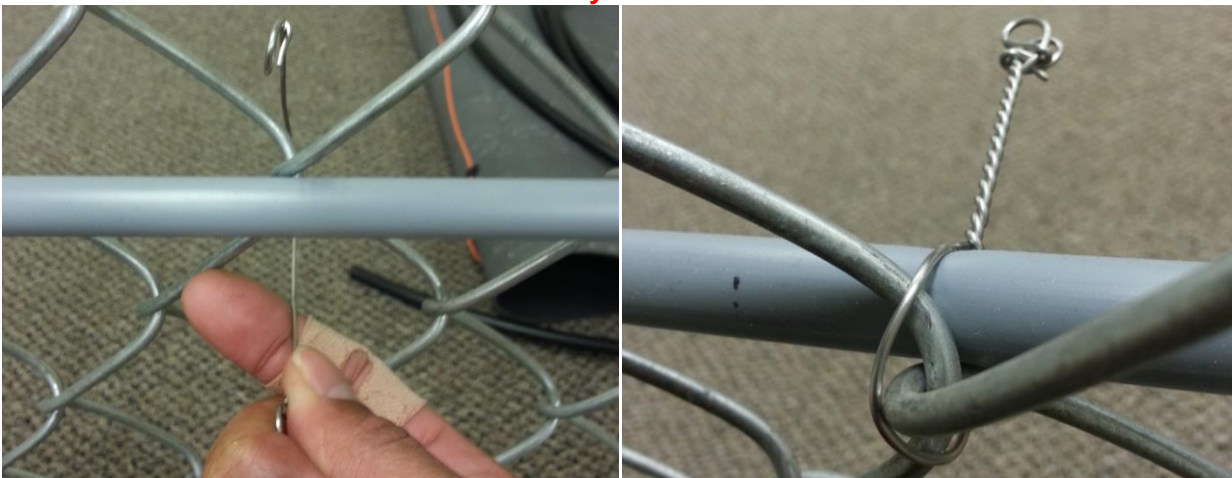

Figure 21b: Observe that there is not a tight fit when the tie is routed through vertically adjacent diamonds

Frequency of Ties and Pull Tension

The disadvantages associated with not adding the proper amount of ties include increased ease of sensor removal and various aesthetic drawbacks. For the best results, add ties every 12 inches (30cm) and as close-fitting as possible on either side of each fence post (figure 22). Removing the sensor undetected becomes nearly impossible if enough ties are added and attached in a high security fashion.

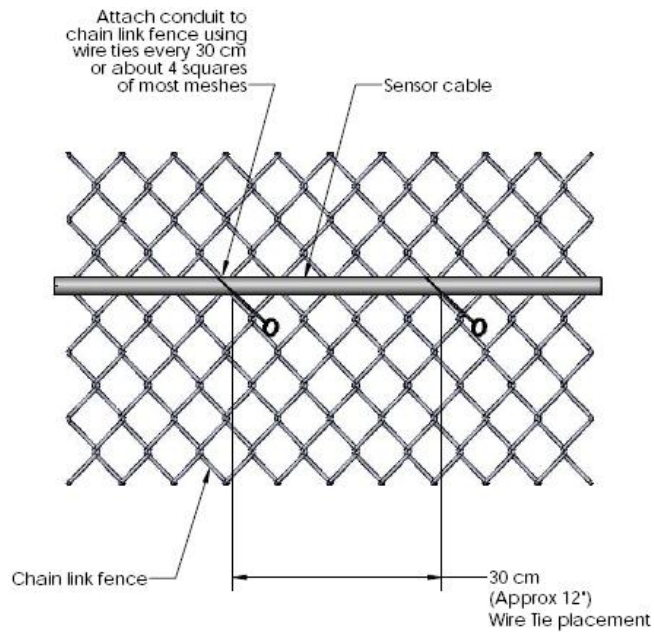

Figure 22: Tie Spacing

Additionally, adding the correct amount of ties and applying approximately 25lb (11Kg) of tension to the conduit during install helps to prevent hot and cold expansion, which results from the conduit expanding during higher temperatures (see figure 23). The tail end of the twist ties may either be left pointing horizontally or bent in a direction of the installer's choosing.



Figure 23: Observe the slight bend in the conduit due to hot and cold expansion; more ties and higher tension would prevent this phenomenon

The sensor cable is also attached to wrought iron fences, barbed wire or razor wire using wire ties. In each case, it is necessary to consider how best to attach the cable so it is less likely to be disturbed by minor nuisances without sacrificing its receptivity to detect the movements or vibrations of an intruder. In the case of wrought iron fences, the cable is attached to the top and bottom rail using wire ties every two vertical fence stakes.

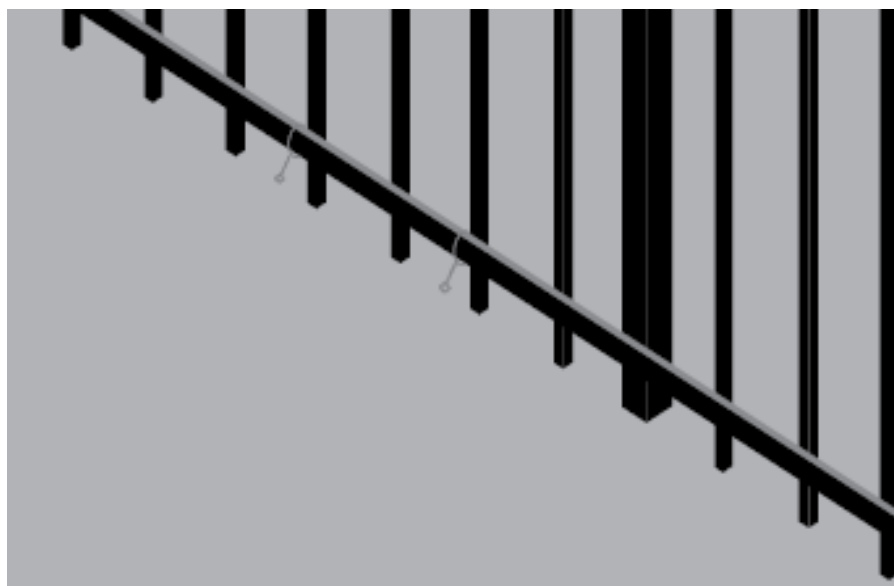

Figure 24: Attaching sensor cable to wrought iron fence

Connecting the Sensor Cable to the APU

Once the sensor cable has been deployed along the fence line it must be connected to the APU.

The FD300 Series APUs use industry-standard ST-type connectors; therefore, it is required that the sensor cable also be outfitted with ST connectors. Connector kits are available from Fiber SenSys for terminating SC-3 and SC-4 sensor cables.

NEMA 4X (IP66) Enclosure

Also available for purchase, Fiber Sensys offers a NEMA 4X (National Electrical Manufacturer's Association) fiberglass enclosure, which is designed to be water resistant and resistant to weather extremes. The APU module itself is rated to 70° C (158° F); however, it is recommended that the enclosure reside indoors or in a shaded area when mounted in hot climates.

The NEMA enclosure comes with a tamper switch that detects when the enclosure is opened.

Mounting the Enclosure

The NEMA 4X enclosure measures 43.8 cm high, 39 cm wide, and has a depth of 21.9 cm (17.25 inches x 15.38 inches x 8.62 inches). Four tapped holes on the back of the enclosure allow it to be mounted using 10-32 screws. Fiber SenSys provides a mounting hardware kit with each enclosure for this purpose. The kit contains four mounting feet and four 10-32 screws.

Refer to the instructions included with the mounting hardware for more information.

The mounting feet can be used for hanging the enclosure from a fence or mounting it on a flat surface. In all cases, the APU should be mounted in such a way that it will be free of vibration. This will prevent the fiber optic leads at the input and output ports from creating false alarm conditions as the result of spurious vibrations of the APU.

Wiring the APU

Conduit entryways must be drilled out of any enclosure that the stand-alone APU is to be mounted in, including the optional Fiber SenSys NEMA enclosure. Optical sensor cables and electrical power/relay wires should be routed to the enclosure through separate conduit entryways. These openings must be sealed once the leads and wires are routed through in order to prevent exposure to dirt or moisture. For additional protection from moisture and dirt, drill the conduit entryways through the bottom of the enclosure.

The optical cables are secured as they are passed into the enclosure by routing them through Kell® connectors or box couplers, available from Fiber SenSys, or other similar connectors that can be made watertight.

With the Fiber SenSys NEMA 4X enclosure, the optical cables must be routed through the strain reliefs along the backplate to prevent stress at either the input or output entryways and connectors of the APU. The use of similar strain reliefs is recommended for any enclosure in which the APU is mounted.

Ensure the 5 cm (2 inch) minimum radius is observed while routing optical cable to the APU.

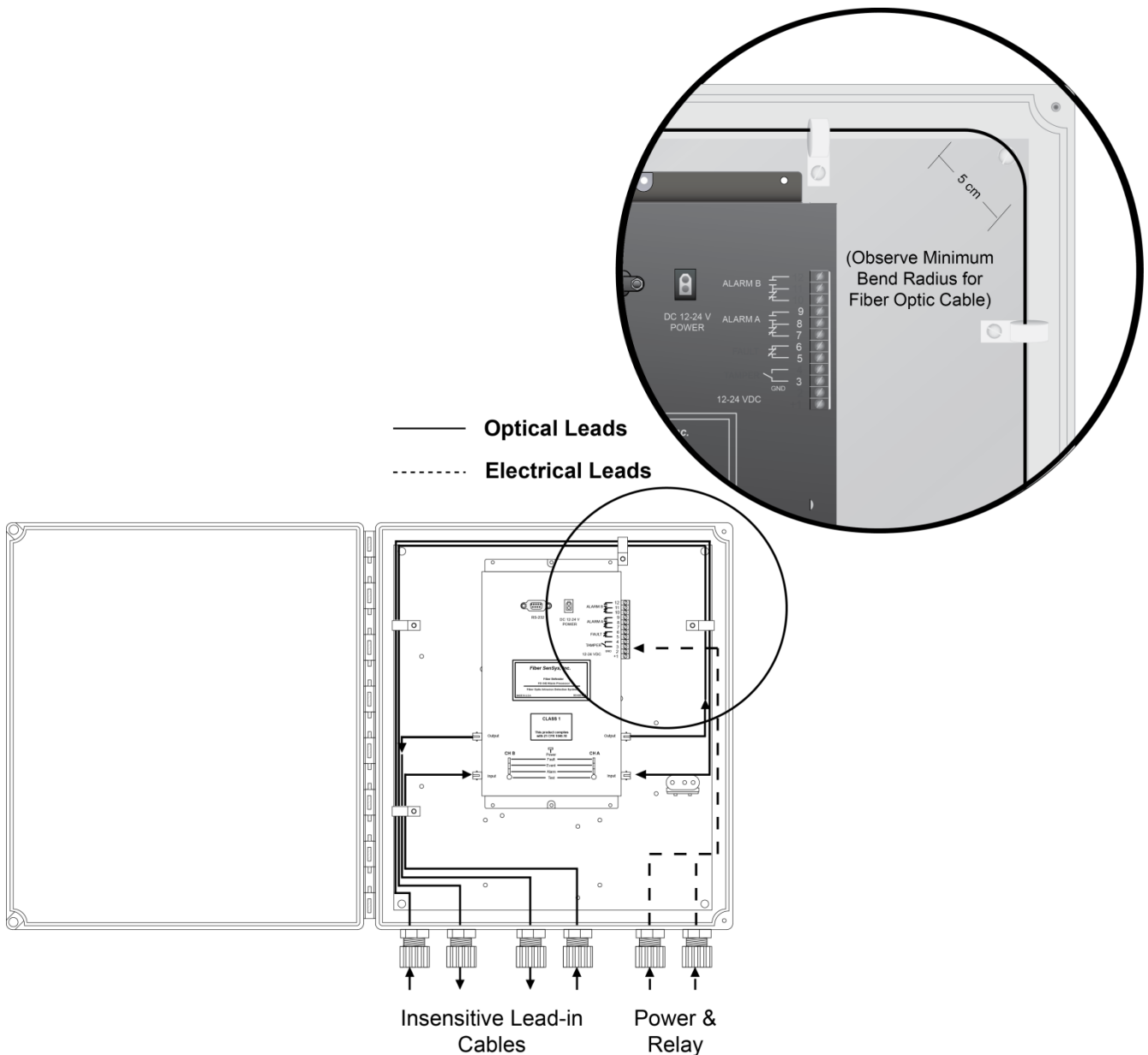

Figure 25: Cable routing inside the NEMA enclosure

Although the conduit entryways are generally drilled into the bottom of the NEMA enclosure (see figure 25), they may be placed anywhere the application requires.

Once the optical connections have been made, wire the APU for electrical power and relay connections. These connectors are located on the right-hand side of the APU. For details on these connectors, see appropriate APU manual.

It is recommended that power leads and relay leads be routed separately through the enclosure to prevent interference.



NOTE:

There may be a significant DC voltage drop in smaller gauge wiring. Ensure the input voltage at Pin 1 is at least 12 VDC following installation.

To increase the security of the installation, it is recommended that either series or parallel resistors (known as supervisory resistors) be added as necessary to ensure that a closed contact condition cannot be simulated by shorting the external relay contact leads together and an open contact condition cannot be simulated by cutting them or removing power. These resistors should be installed inside the NEMA enclosure as close to the terminal connector pins of the APU as reasonable.

It should be noted that if the supply voltage fails or the return optical power drops below the fault threshold on either channel, the Fault relay activates and the normally closed Fault relay contact opens.

As a final step in the wiring procedure, connect the leads of the tamper switch to the tamper contacts on the APU and enable the tamper setting (see appropriate APU manual).

Adding Supervisory Resistors

Adding a **series resistor** to the normally-closed alarm relay contacts ensures a closed contact condition cannot be simulated by shorting the external alarm relay contact leads, preventing an alarm. A series resistance value of 2.74 kilohms is recommended.

Adding a **parallel resistor** to the normally-open alarm relay contacts ensures an open contact condition cannot be simulated by cutting the external alarm relay contact leads, preventing an alarm. A parallel resistance value of 2.74 kilohms is recommended.